



rok założenia
1989

● Okna i drzwi PVC

● Stolarka aluminiowa

WWW.ZEMP.PL

WWW.EXCLUSIVEDOORS.EU



Firma ŻeMP powstała w 1989 roku w Piwnicznej Zdrój. Początkowo zajmowaliśmy się produkcją ślusarki stalowej. W kolejnych latach uruchomiliśmy produkcję stolarki aluminiowej i PVC.

W 2012 Firma ŻeMP wprowadziła do sprzedaży własną markę drzwi wejściowych Exclusive Doors. Drzwi są produkowane w oparciu o systemy PVC KÖMMERLING oraz aluminiowe Schüco.

Produkujemy również elementy ze stali nierdzewnej. Posiadamy własny system szklanych daszków o konstrukcji ze stali nierdzewnej.

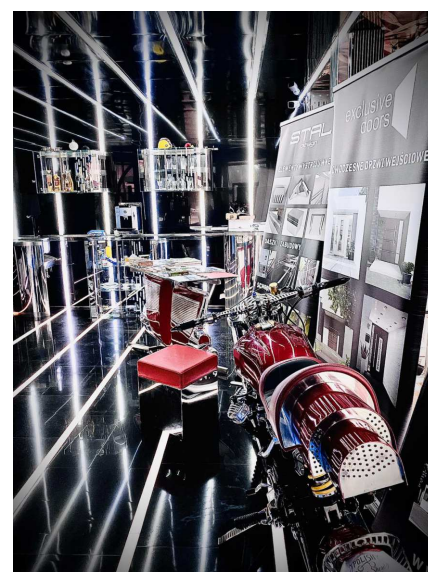



Stolarka PVC

- Okna
- Drzwi wejściowe
- Zabudowy
- Ogrody zimowe



Stolarka aluminiowa Schuco

- Okna
- Drzwi wejściowe exclusive doors
- Drzwi tarasowe przesuwne
- Ogrody zimowe



Stal nierdzewna

- Okna i drzwi
- Daszki
- Balustrady
- Elementy na zamówienie



Okna Kommerling 76md



Okna Kommerling 88 plus



Drzwi Kommerling



Kommerling - systemy ze środkową uszczelką

System KÖMMERLING 76 mm MD wyróżnia się najwyższymi parametrami izolacyjności cieplnej. System z uszczelką środkową osiąga najwyższe parametry izolacyjności termicznej – wartość współczynnika U_f do $1,0 \text{ W}/(\text{m}^2\text{K})$ w wersji standardowej, natomiast U_w dla okna referencyjnego do $0,73 \text{ W}/(\text{m}^2\text{K})$.

Okna, drzwi aluminiowe oraz systemy przesuwne produkujemy w systemach Schüco.

Najczęściej używamy systemów:

- do produkcji okien i drzwi AWS/ADS 70.Hi oraz 75.Si
- w drzwiach tarasowych podnosząco-przesuwnych systemy ASS 70.HI
- w drzwiach panoramicznych systemy ASS 77.PD

SCHÜCO

FIRMA ŻEMP - PRODUCENT OKIEN I DRZWI
ALUMINIOWYCH W SYSTEMACH SCHUCO

Systemy okienne

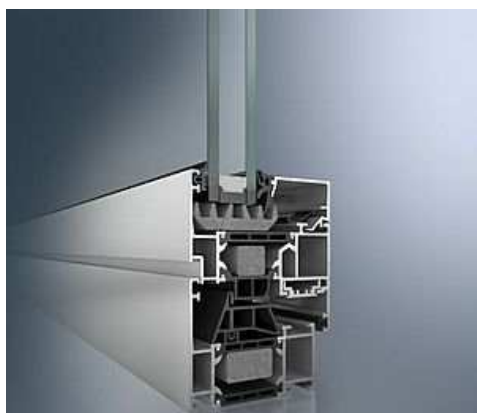

AWS 70.HI

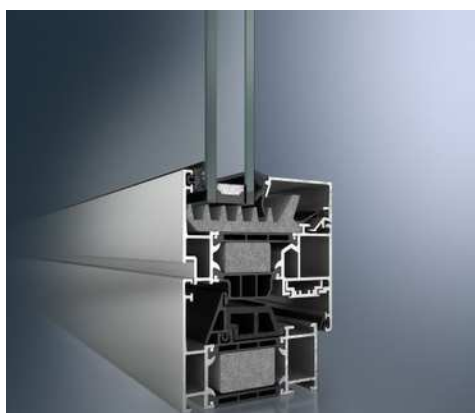

AWS 75.SI

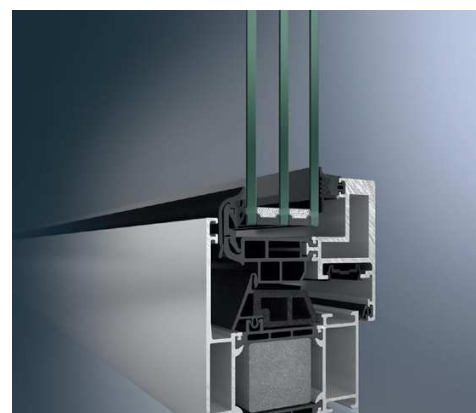

AWS 75.BS.SI

Systemy przesuwne

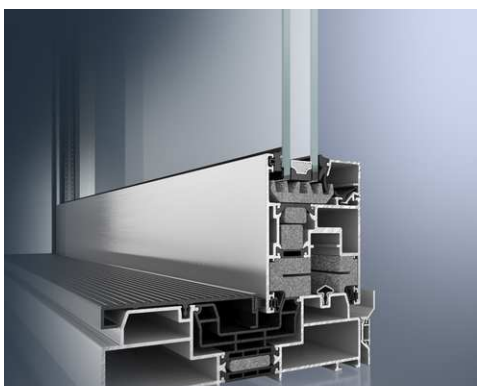

ASS 70.HI

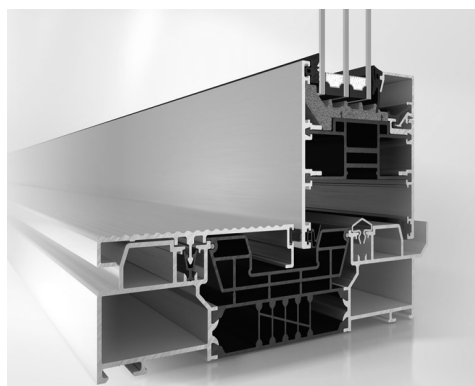

ASE 80.SI

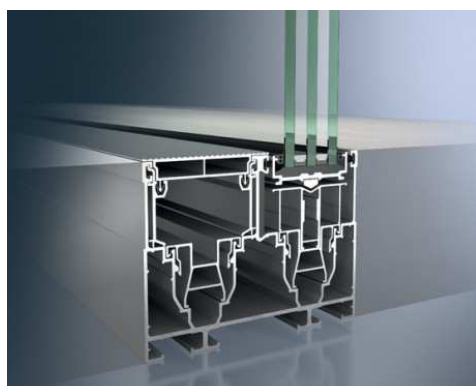

ASS 77.PD

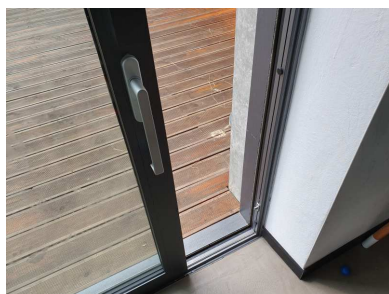



Klamki



Uchwyty

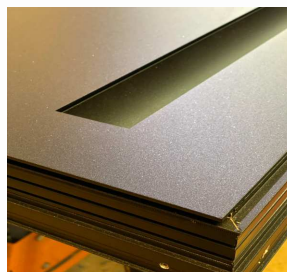

Uchwyt zewnętrzny może być ukryty w skrzydle drzwi, w postaci rury, na całe skrzydło drzwiowe, lub prostokątny .

STANDARDOWE DŁUGOŚCI:
600, 1000, 1500,

Do wyboru ponad 100 wariantów kolorystycznych



Przykładowe warianty konstrukcji drzwi



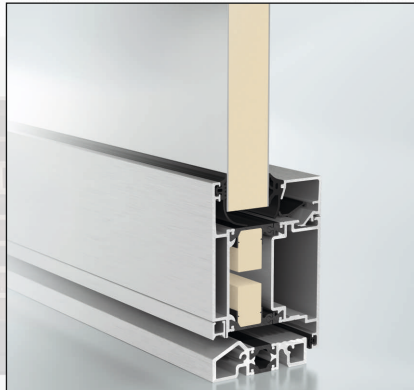

ADS 70.HI panel wsadowy



ADS 75.SI panel nakładkowy 1



ADS 75.SI panel nakładkowy 2



DRZWI EXCLUSVIE DOORS
wykonywane są na zamówienie
dzięki czemu możemy je
dopasować pod każdy wymiar.
Drzwi mogą być w dowolnym
kolorze z palety RAL lub innym.

SCHÜCO

15

Numer domu



Oświetlenie
LED-Spotlight



Moduł wideo



Głośnik



Mikrofon



Przycisk dzwonka
dla jednego lub
kilkulokatorów



Czytnik linii
papiłarnych / Klawiatura



Czujnik ruchu



Dzwonek



Panel komunikacyjny DCS TouchDisplay.

Skorzystaj z kodu QR aby zobaczyć film



DRZWI PIVOT Z PRZESUNIĘTĄ OSIĄ

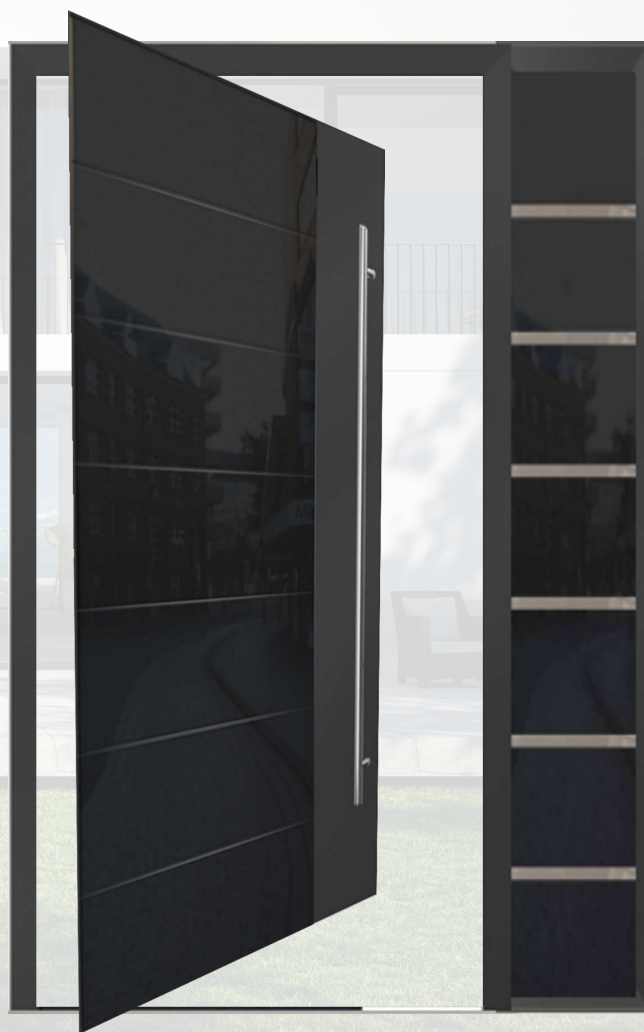

Skorzystaj z kodu QR
aby zobaczyć film





NOWOCZESNY ELEKTRONICZNY WIZJER



DOSKONAŁA
JAKOŚĆ OBRAZU
W PARZE Z PEŁNĄ
DYSKRECJĄ



NIEZAWODNE
ZAWIASY
TO SOLIDNE DRZWI



B-NIEWIDOCZNY



A-WALCOWY

kolory: szary, inox, czarny RAL 9005,
biały RAL 9010, biały 9016



STANDARD

występują we wszystkich kolorach RAL



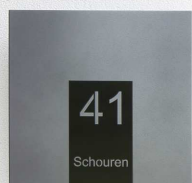

Czytnik linii papilarnych z funkcją Bluetooth



Panel kontrolny DCS



Podświetlone szkło LED



Ukryte zawiasy

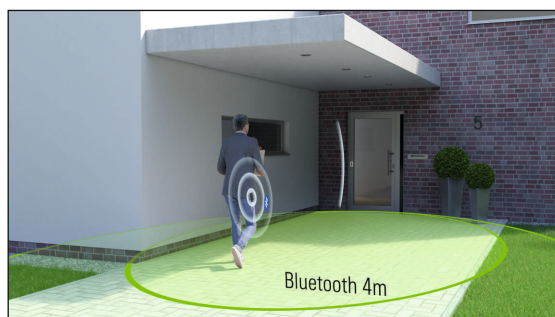

Otwieranie
drzwi przy pomocy
telefonu, z zainstalowaną
aplikacją
Schuco BlueCon

Skorzystaj z kodu QR
aby zobaczyć film





WBUDOWANY
PODŚWIETLANY
PRZYCISK DZWONKA



CZYTNIK LINI
PAPILARNYCH

17



PODŚWIETLENIE
LED

WIZJER



ODKOPNIK

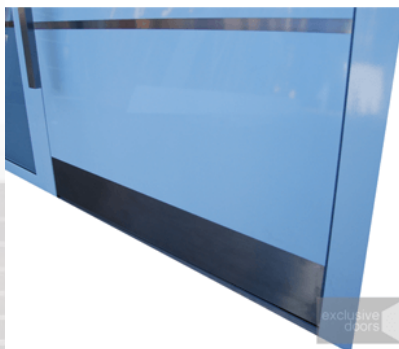

UKRYTY SAMOZAMYKACZ



SKRZYŃKA PRZELOWTOWA



POKRĘTŁO WEWNĘTRZNE





EXD 039



EXD 042



EXD 049



EXD 040



EXD 053



EXD 054



EXD 055



EXD 057



EXD 058



EXD 059



EXD 060



EXD 061



EXD 062



EXD 064



EXD 065



EXD 069



EXD 070



EXD 072



EXD 077



EXD 078



SZKLANE
DRZWI
WEJŚCIOWE
EXD GLASS



EXD GLASS



NOWOŚĆ NA
ŚWIATOWYM
RYNKU

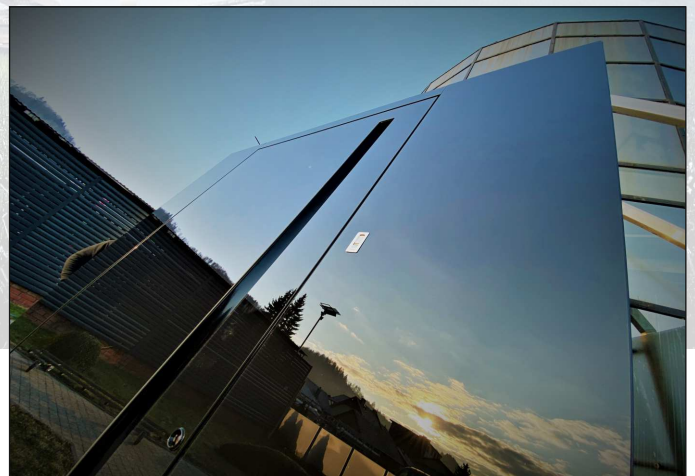

WWW.ZEMP.PL

WWW.EXCLUSIVEDOORS.EU



EXD 002



EXD 003



EXD 004



EXD 005



EXD 006



EXD 007



EXD 008



EXD 009



EXD 010



EXD 011



EXD 013



EXD 016



EXD 019



EXD FLAT



EXD 025



EXD 033



EXD 034

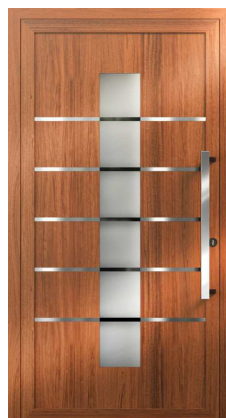

EXD 035

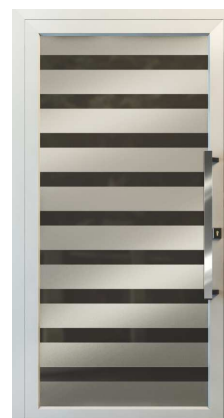

EXD 036



EXD 037



EXD 082 z czytnikiem linii papilarnych



EXD 012 kolor orzech



EXD 012 kolor RAL 7031



EXD 115 z panelem kontrolnym DCS





EXD FLAT

EXD 070

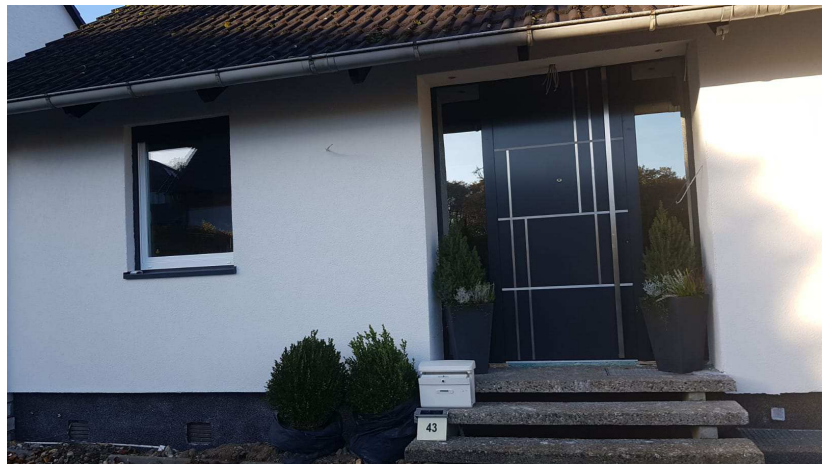

EXD FLAT



EXD FLAT z wbudowanym uchwytem



EXD GLASS- drzwi ze szklanym panelem zewnętrznym

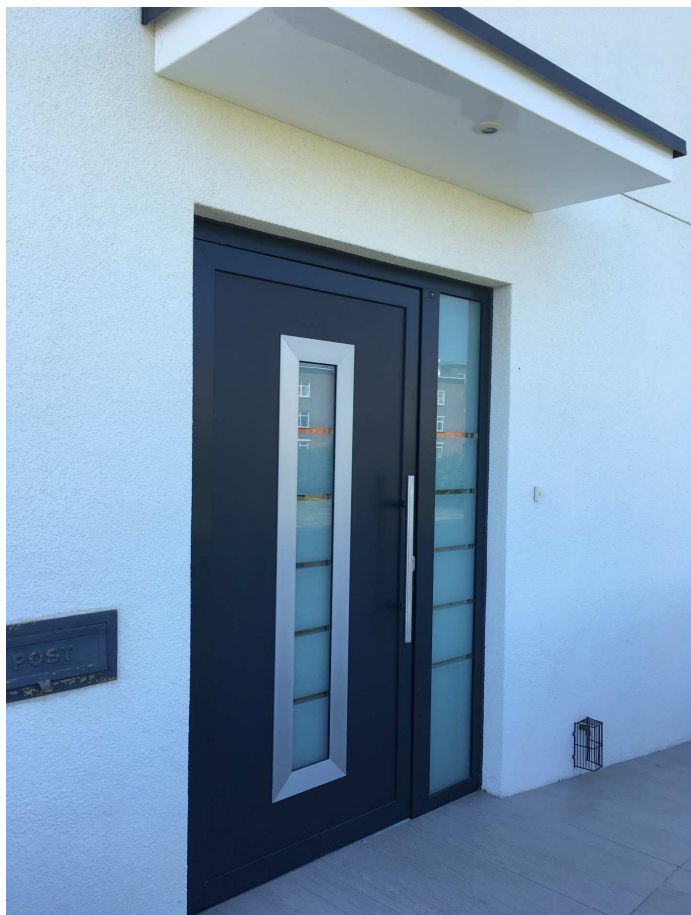

EXD 054

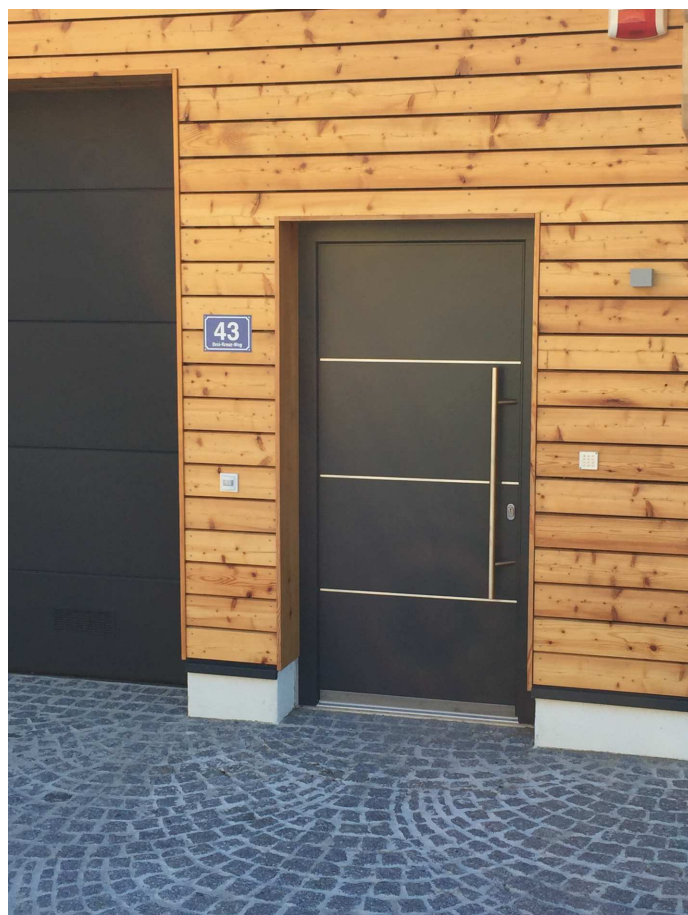

EXD 008



EXD 065

EXD 049



EXD 059

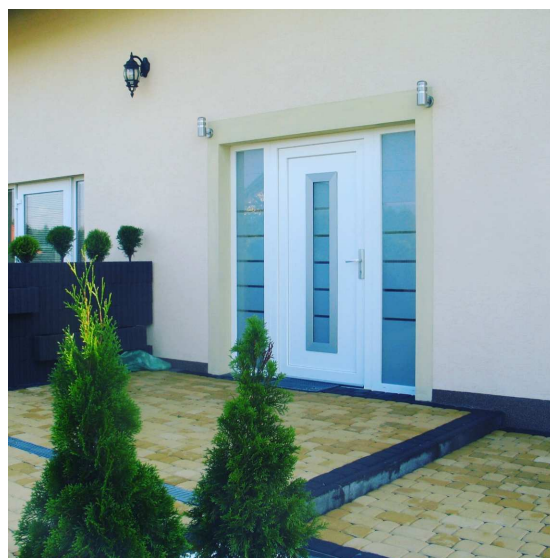

EXD 054



AWS 75 Si



ADS 90 Si

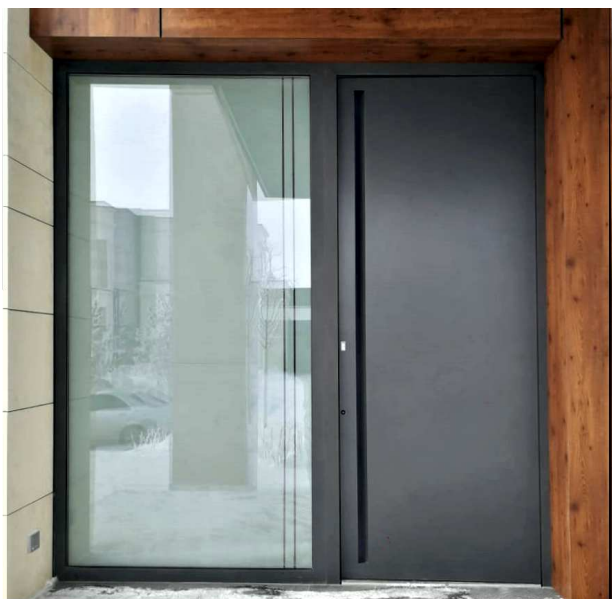



EXD GLASS

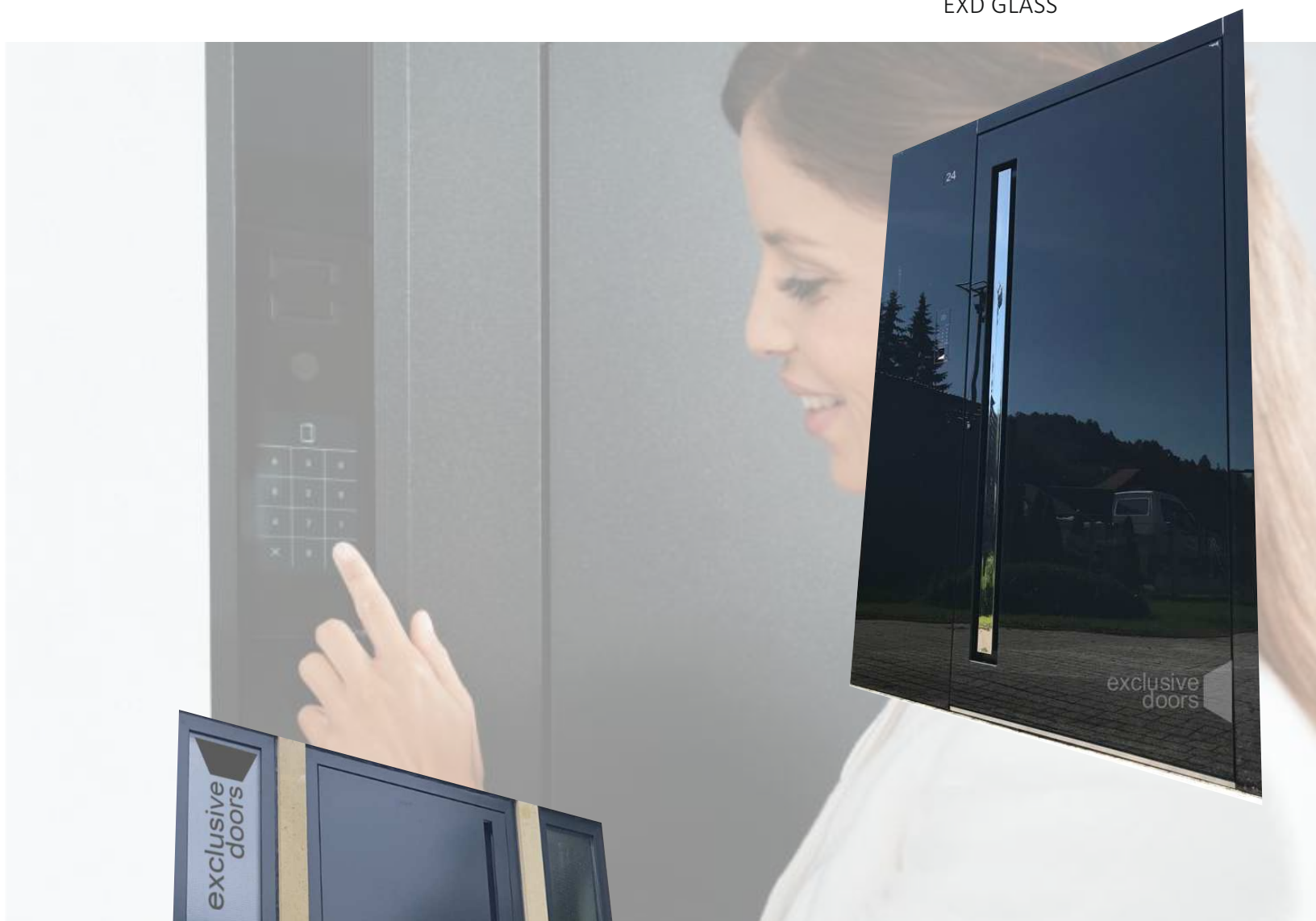

EXD GLASS





ASE 80.Hi



EXD 012

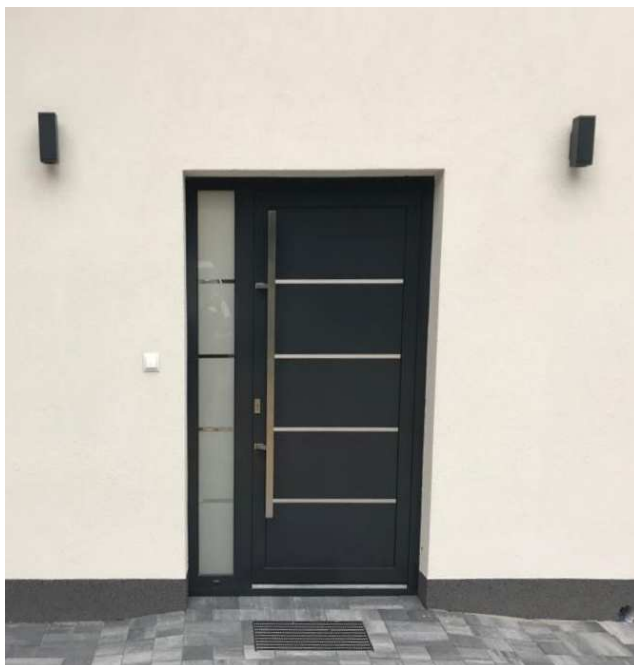

ASE 80.Hi

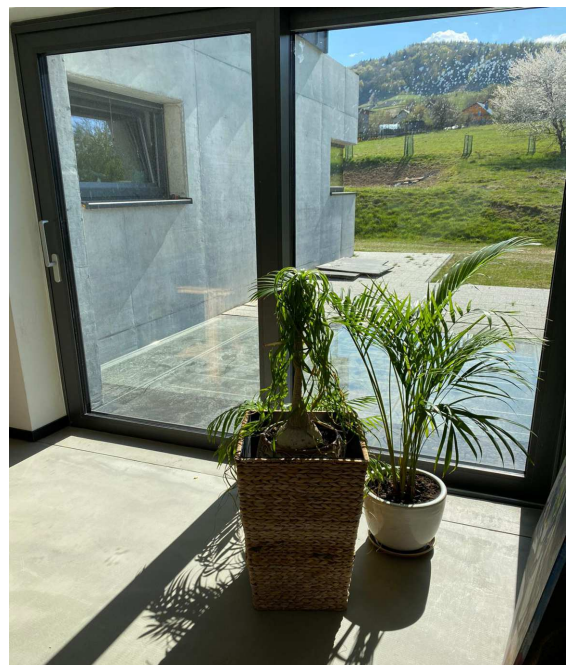

ADS 75 Si





SKONFIGURUJ SWOJE DRZWI

WWW.KONFIGURATOR.ZEMP.PL

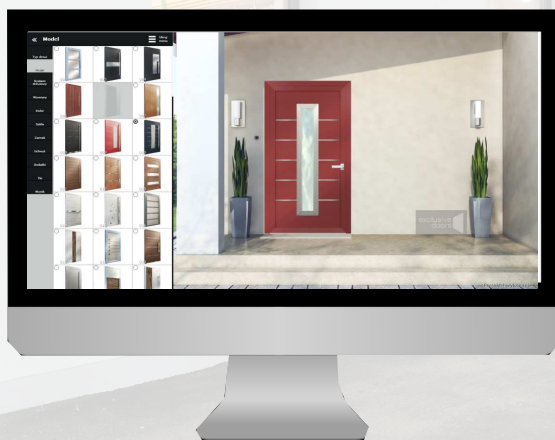

EXD 039



EXD GLASS



EXD 008

rok założenia
1989



exclusive
doors

Firma ŻEMP- Piotr Żytkowicz
ul. Krakowska 24
33-350 Piwniczna Zdrój

FOLLOW US



00 48 18 44 68 483
00 48 602 290 536
00 48 601 269 912

biuro@zemp.pl

WWW.ZEMP.PL

WWW.EXCLUSIVEDOORS.EU